



SWIFT K33

OPTICAL FIBER ARC FUSION SPLICER

USER MANUAL

Read this user manual carefully
before running K33



This device complies with Part 15 of the FCC Rules. Operation is subject to the following two conditions:

- 1. This device may not cause harmful interference.
- 2. This device must accept any interference received, including interference that may cause undesired operation.

Device Type

A Class Device
(Broadcasting and communication device, Commercial use)

Notification

Users need to understand that this device (A Class) has obtained EMI(Electromagnetic compatibility) and been designed to be used in places other than home.

Tel. 82) 42 671 5607-8
Website www.uclswift.com
E-mail sales@uclswift.com

FOR YOUR SAFETY 4

SPECIFICATIONS 7

General specifications 7
 Components 9

PRODUCT DESCRIPTION 11

Part name of Swift K33 11
 Function buttons 12

OPERATION 13

Supplying power to the Swift K33 13
 How to check remaining battery capacity 15
 Turn on the Swift K33 16
 Installing the sleeve loader 16
 Inserting the fiber into the sleeve 17
 Optical fiber cleaning and stripping 17
 Cleaving the fiber 18
 Load the fiber to the Swift K33 18
 Splice 19

Swift K33 sleeve-heater part 20
 Separation of connected optical fiber 22
 Heating for protecting sleeve 22

MAINTENANCE OF SPLICE QUALITY 23

Cleaning and inspection before splice 23
 Regular cleaning and inspection 25

MENU 28

Menu 28
 Pop-up menu 30
 Splice 33
 Sleeve heater 45
 History 51
 Option 52
 Calibration 54
 Electrode 57
 Setting 59
 Information 61



ERROR MESSAGE	63
Too dirty fiber	63
Replace the optical fiber	63
Too long fiber	63
Fiber over angle	64
Loss is higher	64
Core bubble error	64
Optical fiber is thick	65
Optical fiber is thin	65
Error on cut surface on left, right or both	65

HOW TO DEAL WITH SPLICING PROBLEMS	66
When the splice loss is too high	66
Abnormal operation of arc fusion splicer	67

Q & A	68
Power	68
Splice	69
Sleeve heater	70
The others	71

WARRANTY PERIOD AND SERVICE	72
Information required for repair	72
Transport	73
Repair	73



KEEP THIS
USER MANUAL
WITH THE
DEVICE
AT ALL TIMES

The Swift K33 is designed to satisfy the user's convenience for both outdoor and indoor use, allowing the operation easy and simple.

Still, we strongly recommend our customers to read this user manual carefully prior to running the Swift K33 in order to prevent any accident and breakdown because improper handling may cause danger.

This user manual provides all the necessary information to ensure splicing safely.

UCLSWIFT Co., Ltd is not liable for any personal injury, any physical loss and damage to device caused by inappropriate use or unauthorized modification of the equipment.



⚠ WARNING

Please, turn off the Swift K33 and disconnect the AC power cord from the AC adapter inlet or the wall socket immediately and contact UCLSWIFT Co., Ltd. If any of following incidents occurs while operating.

- Fumes, odor, noise or over-heating.
- Liquid or foreign substances fall into the device.
- The splicer is dropped or damaged.

Use the supplied power cord with the Swift K33 only. Using an improper AC power cord may cause fire, electric shock or personal injury.

DO NOT touch the electrode when the Swift K33 is on. The high voltage and temperature generated by electrode may cause electric shock or burn.

Connect the supplied AC power cord to the battery. Check to ensure no dust or foreign substance on the AC plugs before connecting it. Unsafe connection may cause the fumes, fire or damage to the Swift K33 and result in serious personal injury or death.

DO NOT touch the AC plugs, AC power cable or the Swift K33 with wet hands. It may cause an electric shock.

Apply correct voltage. The correct input AC power to the adapter is AC 100-240V and 50-60Hz. Abnormally high AC output voltage or irregular frequencies are often generated by AC generator. Please measure the AC output voltage with a circuit tester. Since abnormal high voltage and frequencies may result in serious electric shock, injury, death or damage

to the equipment, it is important that regularly check the generator before use. **DO NOT** excessively pull, amend, misuse or apply heat to the AC power cable. Using a damaged power cable may result in fire or personal injury. Connect 3-core AC power-cord. **DO NOT** use 2-core, able and plug.

DO NOT disassemble the AC adapter, battery or the Swift K33. Any modification may cause fire, electric shock or personal injury. When using the battery, follow instructions below.

- Using battery other than in the package or provided by UCL SWIFT Co., Ltd may cause fumes, damage to the device, burn, serious injury or even death.
- **DO NOT** throw the battery into fire or an incinerator.
- **DO NOT** charge the battery near a flame.

- **DO NOT** apply excessive shock to the battery.
- If the battery isn't fully charged or the green LED is not turned on in about two hours, stop charging immediately and contact UCLSWIFT Co., Ltd.
- **DO NOT** put anything on the AC adapter while charging.

Use the supplied AC adapter (F1-1) at all times. **DO NOT** use other type of AC power cord and the battery. Excessive electric current may cause damage to the machine and personal injury.

DO NOT run the Swift K33 near flammable liquid or explosive gas storage. The electric arc of the Swift K33 may cause fire or explosion.

DO NOT clean the Swift K33 using compressed air or gas.

Please check the shoulder

belt before transporting. Transporting the case with a damaged shoulder belt, it may cause the damage of the Swift K33 and the personal injury.

Make sure to wear protective glasses while performing splicing works. If the fiber fragments come into contact with the eye or skin, it can be extremely dangerous.

DO NOT operate the Swift K33 at a high temperature or near heat, otherwise personal injury or damage to the device may occur.



EXTREMELY HOT



DO NOT SPRAY
FREON GAS



CAUTION HIGH
VOLTAGE

⚠ CAUTIONS

DO NOT touch the sleeve heater or the sleeve during or immediately after heating them. The hot surface may cause skin burn.

DO NOT place the Swift K33 in an unstable or unbalanced position. The machine may fall, causing injury or damage to the Swift K33.

The Swift K33 is precisely adjusted and aligned. **DO NOT** allow the unit to receive a strong impact. Use supplied carrying case for its transportation and storage. The carrying case protects the Swift K33 from damage, moisture, shake and shock during storage and transportation.

Replace the electrodes in a timely manner and maintain them as instructed below.

- Use only a specified electrode.
- Place a new electrode in the correct position.

- Replace the electrodes as a pair.

Incompliance with above instructions may cause abnormal arc discharge, resulting in damage to the machine or degradation in splicing performance.

Use no chemicals other than ethyl-alcohol (96% or greater) to clean the objective lenses, V-groove, V-block, LCD monitor and body of the Swift K33. Otherwise, blurring, discoloration, damage or performance deterioration may occur. The Swift K33 requires no lubrication. Oil or grease may degrade its performance and damage the equipment.

DO NOT store the Swift K33 in a place where temperature or humidity is high. Damage to the machine may occur.

Technical aspects of Swift K33 should be inspected by a qualified expert. When ignoring this, it may incur fire or electric shock. Discuss with UCLSWIFT Co., Ltd to use the service.

GENERAL SPECIFICATION

Subject	Description
Fiber Alignment	IPAAS Core Alignment
Applicable Fibers	SM(G.652), MM(G.651), DS(G.653), NZDS(G.655), SM(G.657 A1, A2/B2, B3), SM(G.654E)
Fiber Count	Single Fiber
Applicable Fiber Dimensions	Cladding diameter: 80~150 μ m Coating diameter: 100 μ m-3mm
Fiber Cleave Length	250 μ m: 5~16mm, 900 μ m: 8~16mm
Splicing Modes	Splice mode: 300 Heat mode: 100
Average Splice Loss	SM: 0.02dB, MM: 0.01dB, DS: 0.04dB, NZDS: 0.04dB

Return Loss	> 60dB (Typical)
Splicing Time	Typical 6 sec. (Quick Mode)
Storage of Splice Result	The last 10,000 results to be stored in the internal memory. (Image 10,000 results)
Tension Test	1.96N ~ 2.25N
Applicable Protection Sleeve	32mm, 40mm, 60mm (Fiber) 28mm or 32mm (Connector)
Splice Loss Estimate	Available
Sleeve Heating Time	9 sec (IS-45 Sleeve, IS-45 mode), 13 sec (IS-60 Sleeve, IS-60 mode)

Storage Conditions Temperature: -40°C~80°C,
Humidity: 0~95%

Operating Condition Altitude: 0~5,000m above sea level
Temperature: -10°C~50°C
Humidity: 0~95%,
Wind: 15m/s
Non-condensing,
Dust proof, Water proof,
Shock proof

Weight 2.25kg (Including battery)

Dimensions 130(W) x 158(L) x 138(H)mm
(Excluding bumper)

Fiber view and Magnification X/Y: 200X, Max 670X

Viewing method and Display Two CMOS cameras and 5.0-inch color LCD monitor with Electrostatic touch screen

Power Supply 100 ~ 240V AC

Battery life with Heat-shrink 270 cycles with 4,700mAh & 350 cycles with 6,000mAh

Electrode Life Up to 18,000 splices

Terminals USB, External Power

COMPONENTS

Standard Items

Description	Model No.	Quantity
Arc Fusion Splicer	SWIFT K33	1
User Guide	Download from UCL Swift Website (uclswift.com)	-
Battery	K3347(4,700mAh)	1
Transporting Case	Hard Case	1
AC Adapter	-	1
Cleaver	CS-01BT	1
Manual Stripper	CF-02	1
Alcohol Dispenser	PP	1

Tool box	-	1
USB Cable	-	1
Sleeve Loader	-	2



Optional Items

Description	Model No.
Battery	K3347(6,000mAh)
Cleaver Blade	BI-07
Electrode	EI-23
Optical Fiber Holder	HS-250, HS-900, HS-2.5F, HS-IN, HS-SC/FC, HS-ILC, HS-ST, LS-900 (Loose tube)
External Power	DC 12V available for car cigar jack
Sleeve	S-160 (60mm), S-140 (40mm)
Sleeve Clamp	-
Wifi Card	-

Work Belt	-
SOC Connector	SC, LC, FC, ST(refer to FTTx solution catalogue)

PART NAME OF SWIFT K33

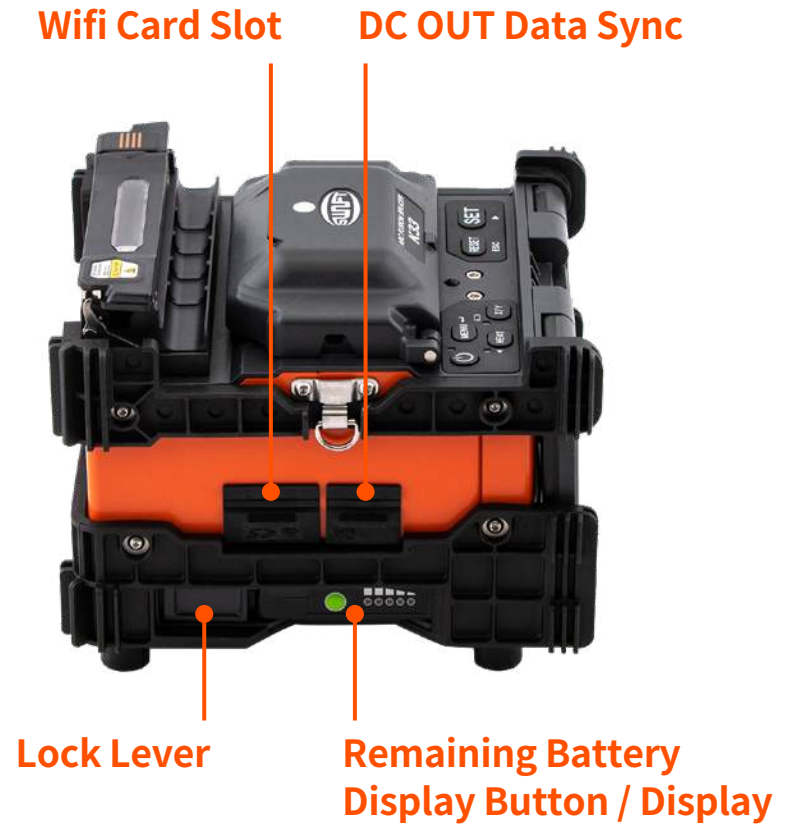

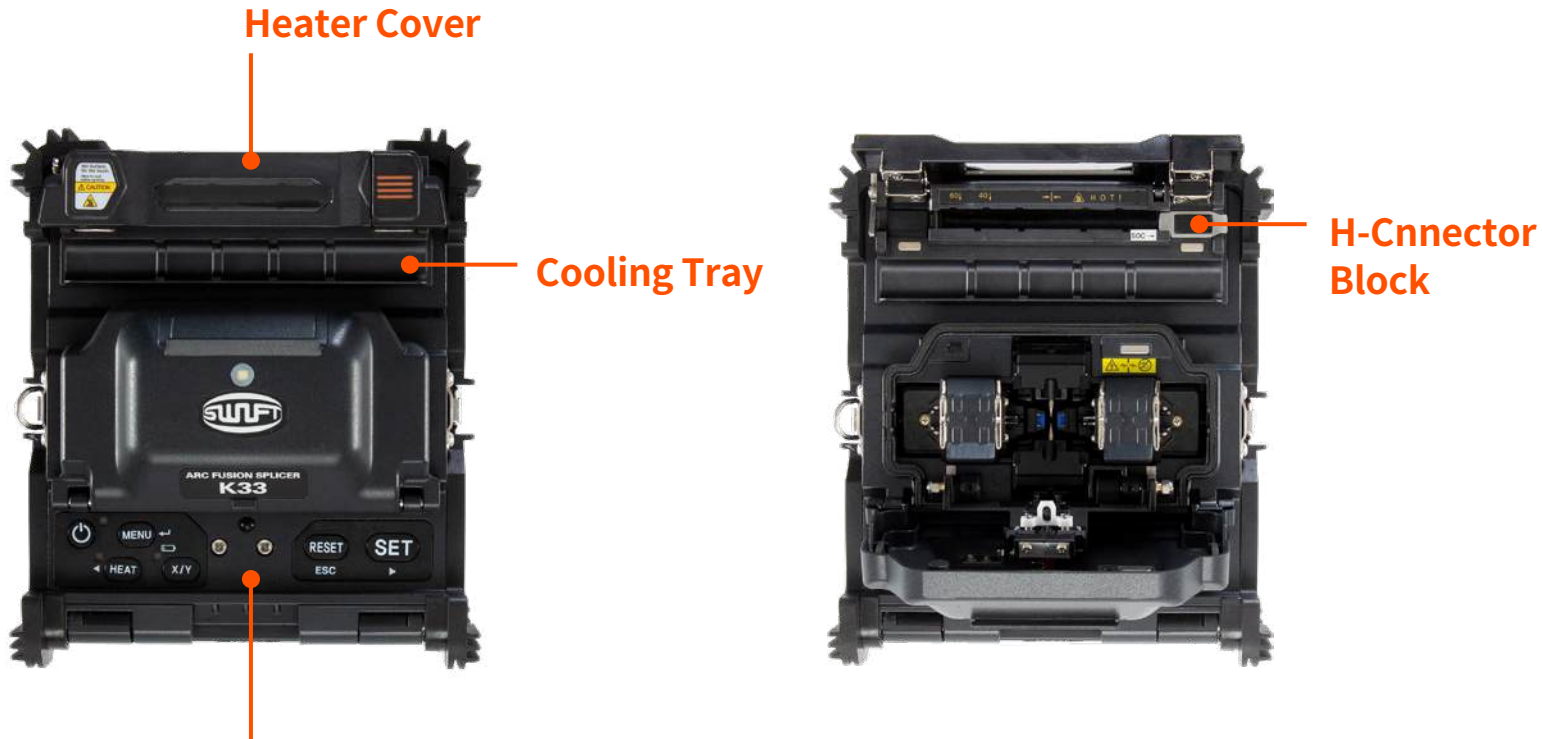

Function Button

 To turn the power on/off-press button for about 1.0 second. Press for about 1 second in POWER ON status, the LCD monitor turns off. Turn off the power after 2~3 seconds.

HEAT To activate the sleeve heater

X/Y To X/Y screen conversion

MENU To call the main menu screen

SET To execute splicing command

RESET To return to the initial screen, To initialize the splicing function

SUPPLYING POWER TO THE SWIFT K33



Inserting the Battery

Insert the battery into the battery groove until it clicks.

Detaching the Battery

Please make sure the power is off before removing the battery. Remove the battery by releasing lock lever.

- ⚠ It is strongly recommended to use the AC adapter (F1-1) and battery (K3347) provided with package. Using a battery other than provided may cause fumes, fire, and damage to the device, personal injury and death.

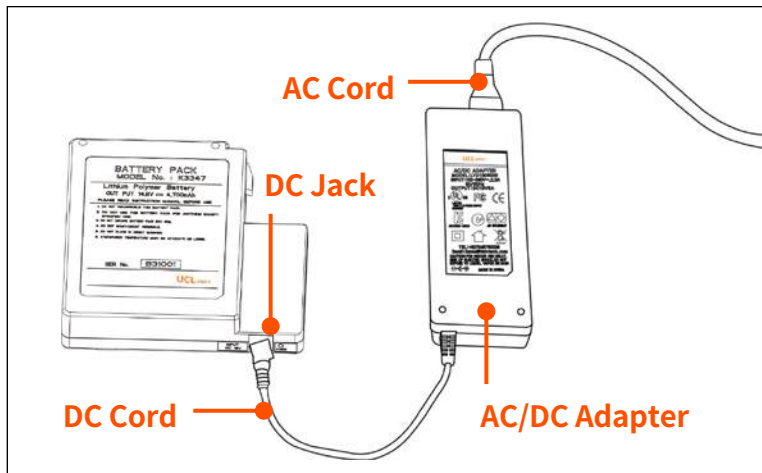













Make sure the voltage and frequency and connect the DC cord of the AC/DC adapter to the DC jack of the battery. The LED turns to green when the charging is completed. The battery includes the protection circuit that prevents full discharge and full charge. The supply of power stops once the protection circuit is activated. In order to deactivate the protection circuit and resume feeding power, wait about 10 seconds and connect again the DC cord to the DC jack.



Swift K33 can be charged during operation because the floating charging method is applied. The battery can be also charged with 12V Cigar jack charger.

HOW TO CHECK REMAINING BATTERY CAPACITY

⚠ It is strongly recommended that the battery must be charged as remaining capacity reaches to 10% (1 bar). If not, there occurs the splice loss.

Percentage Remains	Remaining Battery Amount (Monitor)	Remaining Battery Capacity Display (LED)
80 - 100 %	 5 BARS	 5 LED
60 - 80 %	 4 BARS	 4 LED
40 - 60 %	 3 BARS	 3 LED
20 - 40 %	 2 BARS	 2 LED
10 %	 1 BAR	 1 LED
5 or less %	 NO BAR	 Nothing Displayed

TURN ON THE SWIFT K33



Press  and hold for about 1.0 second without opening the windshield cover. The initial screen is displayed as above after resetting all their initial functions. It is important to choose a right splice and heat mode to ensure an accurate splicing result. The current splice and heat mode are displayed at the bottom of the initial page.

INSTALLING THE SLEEVE LOADER



Get the sleeve loader installed as follows.

INSERTING THE FIBER INTO THE SLEEVE

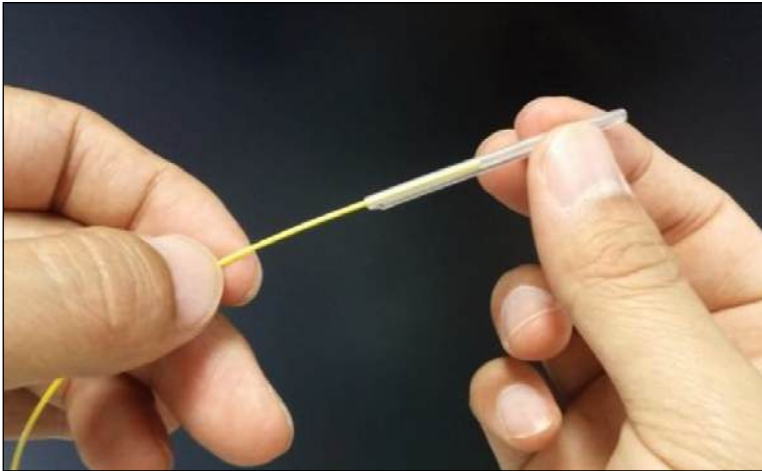

Insert the fiber into the sleeve.

OPTICAL FIBER CLEANING AND STRIPPING

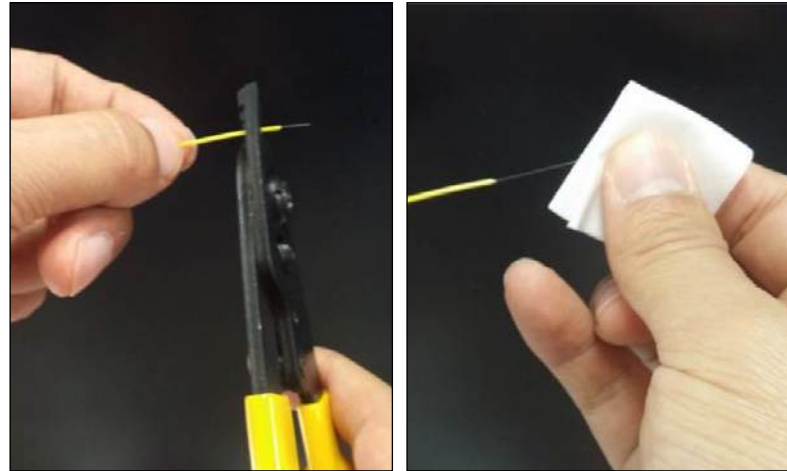

Do stripping procedure on about 4cm from the end of optical fiber by using sheath stripper. And wipe the optical fiber clean with soft cloth or cotton moistened with alcohol

⚠ Use high quality ethyl-alcohol with higher than 96% purity.

CLEAVING THE FIBER

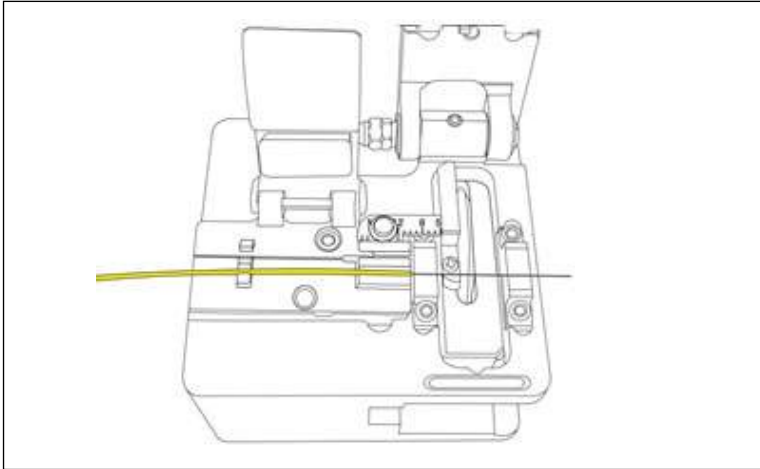

- 1 Install the optical fiber on cutter as shown in the figure below and check optical fiber's state and cutting length.
- 2 When optical fiber is not properly installed, problems may be incurred on cutting procedure.
- 3 Pull down and press the cover to cleave the fiber. Lift the cutting lever and take the optical fiber out.
- 4 Remove the fiber fragments and dispose it in a proper container.

⚠ Please read user manual of the cleaver for more detailed information about the operation of the cleaver.

LOAD THE FIBER TO SWIFT K33

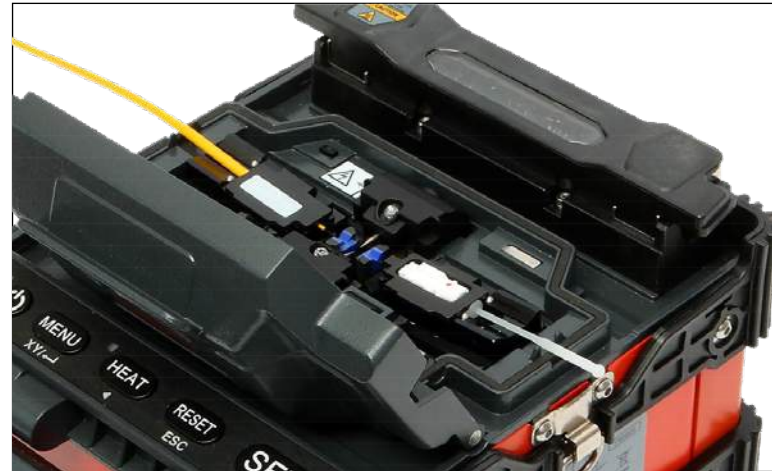

- 1 Open the windshield cover and optical fiber.
- 2 Put optical fiber between V-Groove and electrode. Be careful not to make the tip of prepared optical fiber bump against other objects.
- 3 Fix the optical fiber with hands to prevent its move and close the clamp with care.
- 4 Install the optical fiber on the opposite side in the same way.
- 5 Close the windbreak cover with care.

⚠ The better the optical fiber is installed at a proper location, the shorter it takes for arrayal.

SPLICE

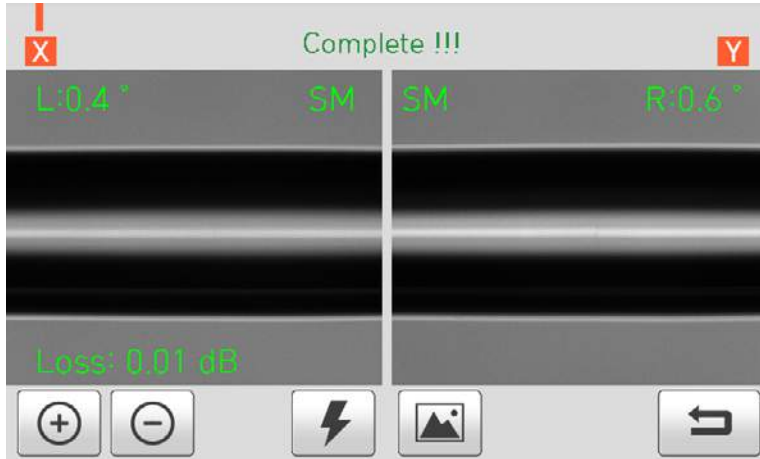

The condition of the fiber can be observed via the image processing system in the Swift K33. However, the visual inspection is necessary to ensure better splice result. The splicing process starts as soon as the windshields cover is closed in Auto mode.

- 1 The fibers loaded in the splicer move toward each other. The movement stops at the positions after the fiber cleaning arc. Then the splicer checks cleaved angle, end-face quality and dust. If the measured cleaved angle is bigger than the preset limit value or any damage of the fiber is discovered, an error message

appears on the screen and the splice process stops. Though no error message appears on the screen, visual inspection on cross section is recommended as the process stops.

- 2 Optical fibers are arrayed core vs core after inspection. Deviation on clad axis and deviation measured on core axis can be displayed on screen.
- 3 After alignment completes, arcing is conducted to splice fibers.
- 4 After splice completes, estimated loss value is displayed on screen. Estimated value of splice loss is subject to various factors related to error. These factors related to error affect estimation and calculation of estimated loss value as well. Calculation of estimated loss is based on factors such as MFD. When estimated loss value exceeds the preset limitation, error message is displayed on the screen. The error message is also displayed when the spliced optical fiber is too thick or thin or when bubbles are generated on the joint. Even when there is no error message displayed, however, it is recommended to conduct sealing yet again when the splice result on screen is considered not good enough.
- 5 Splice result is saved as follows. When splice completes, splice result is automatically saved.

SWIFT K33

SLEEVE-HEATER PART

Sleeve heating part of K33 realizes reinforcement of single optical fiber subject to sealing splice. State of sealing splice on optical fiber should be appropriate. Optical fiber that sleeve tube is inserted to heater should be appropriately arrayed and installed. Heater cover should be closed upon sealing.

Cable Diameter	250 μ m, 900 μ m, 2.0mm ~ 3.0mm
Sleeve Length	20 ~ 60mm
Sleeving Time	5 ~ 150 sec
Temperature	130 $^{\circ}$ C ~ 200 $^{\circ}$ C



Optical Fiber

- 1 Choose the heater mode after the confirmation of the length for the sleeve tube when placing a sleeve tube on a heater.
- 2 Place the spliced point in the middle of the sleeve tube first. Then, checking out the heating part on the heater and place the sleeve tube on right position.



- 3 After placing the optical fiber on the heater, press **HEAT** button to start the heater. (Operation time: about 20 seconds).
- 4 When the heater is complete, open the cover and remove the fiber reinforced cooling Tray to go to the cooling sleeve.



Soc Connector

sleeve tube properly. Especially, SOC (Splice-On-Connector) should be placed on the right side edge of the heater in order to line up the right end of the sleeve tube to the right side edge of the heater as shown on the picture below (Right picture).

- ⚠ Choosing improper mode of the heater for a sleeve tube may not shrink the

picture). If SOC is placed in the middle or on the left side, sleeve tube of the SO does NOT shrink.

SEPARATION OF CONNECTED OPTICAL FIBER

- 1 Open the cover of sleeve heater.
- 2 Open the windshield cover.
- 3 Hold the optical fiber on the left and open the clamp on the left.
- 4 Open the optical fiber clamp on the right.
- 5 Hold the both sides of spliced optical fiber and separate optical fiber from Swift K33 with care.

HEATING FOR PROTECTING SLEEVE

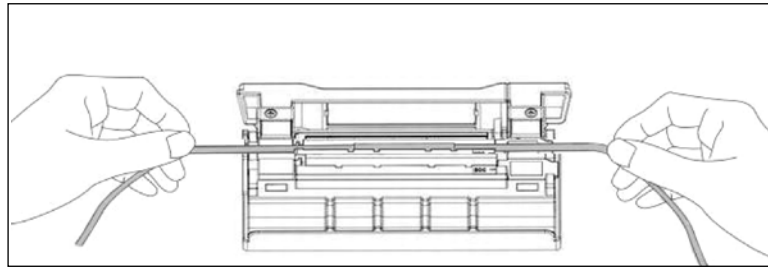

- 1 Move a splicing point to the center of protecting sleeve. Make the protecting support of sleeve face the bottom.
- 2 Place the protecting sleeve at the center of sleeve heater.
- 3 Hold the both sides of optical fiber and pull downwards as shown in the figure and the heater cover is automatically closed.
- 4 Heating starts by pressing **HEAT**
- 5 LED is turned off when heating completes.
- 6 Open the heater cover and separate optical fiber. Do not touch protecting sleeve or heater right after the heating.
- 7 Conduct final inspection on whether there are bubbles, fragments or dusts on sleeve.

CLEANING AND INSPECTION BEFORE SPLICE

V-Groove Cleaning

When the inside of V-Groove is contaminated, splice quality may deteriorate. Thus, it is important to regularly inspect and frequently clean the V-Groove as follows.

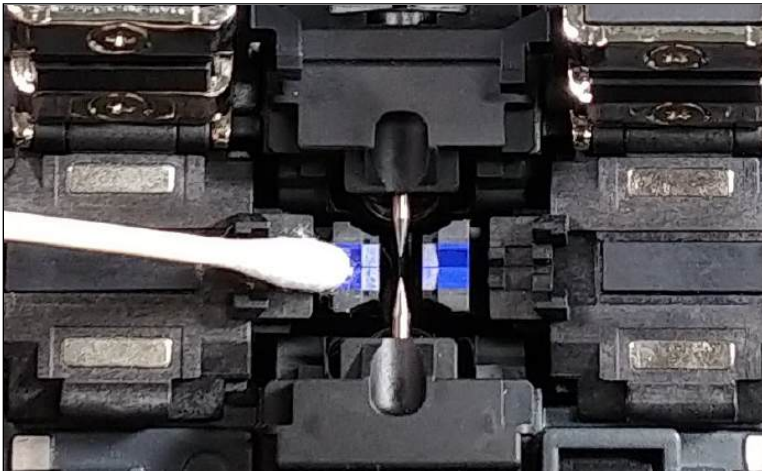

- 1 Open the windbreak cover.
- 2 Clean the V-Groove using cotton swab moistened with alcohol. Remove the alcohol remaining on V-Groove using a clean and dry cotton swab.

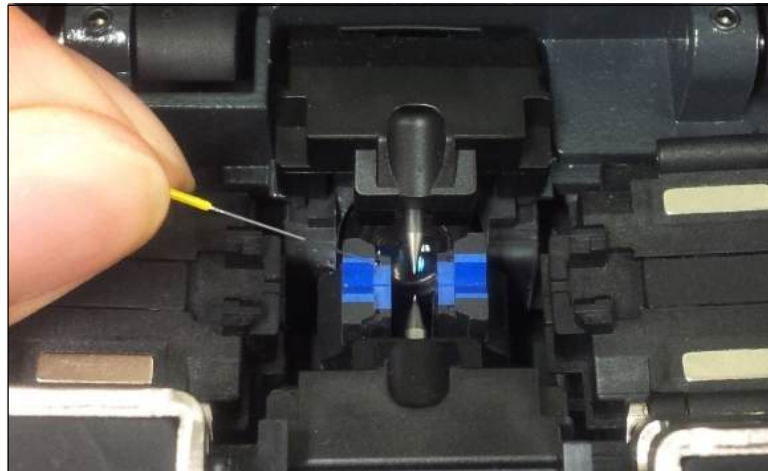

- 3 When a foreign substance is not removed with cotton swab, clean it with the tip of cut optical fiber and then repeat the step above.

Pusher Block Cleaning

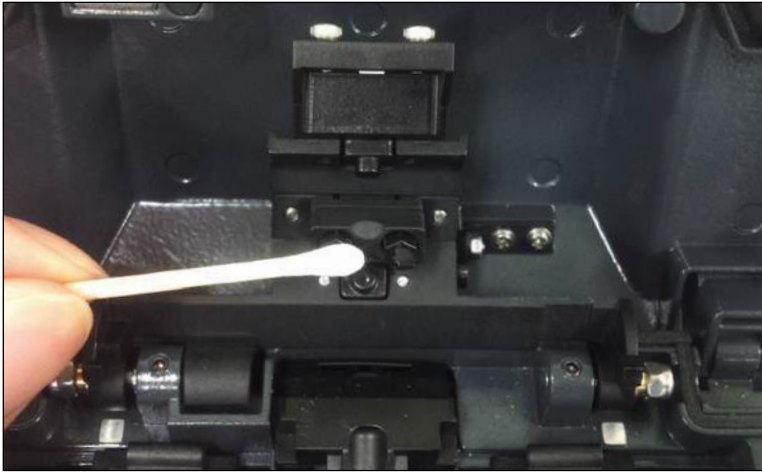

Contaminations remaining on Pusher Block incur poor splice quality with influence on pusher block location. Thus, it is important to frequently inspect and regularly clean it.

Cutter Cleaning

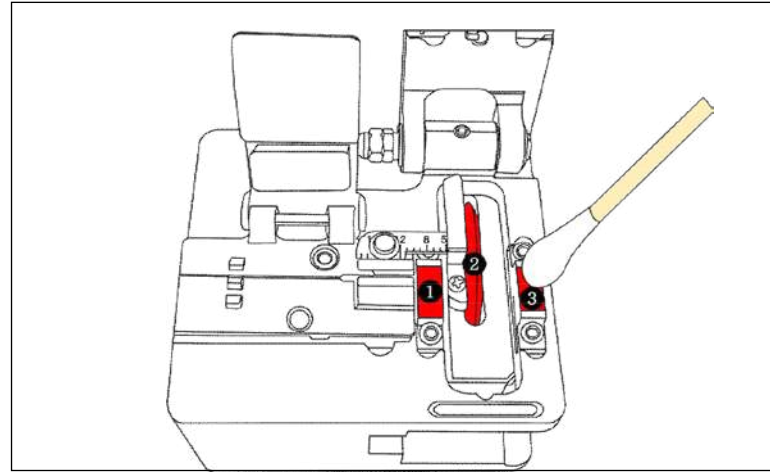

When cutter's blade and fixing pad is contaminated, cutting quality may deteriorate. Splice loss can be consequently increased. Thus, clean the cutter blade and fixing pad frequently using cotton swab moistened with alcohol. It is critical to keep the cutting quality of optical fiber. (Do not use acetone or solvent when cleaning the rubber pad.)

REGULAR CLEANING AND INSPECTION

To keep sealer's splice quality, regular inspection and cleaning is required.

Object Lens Cleaning

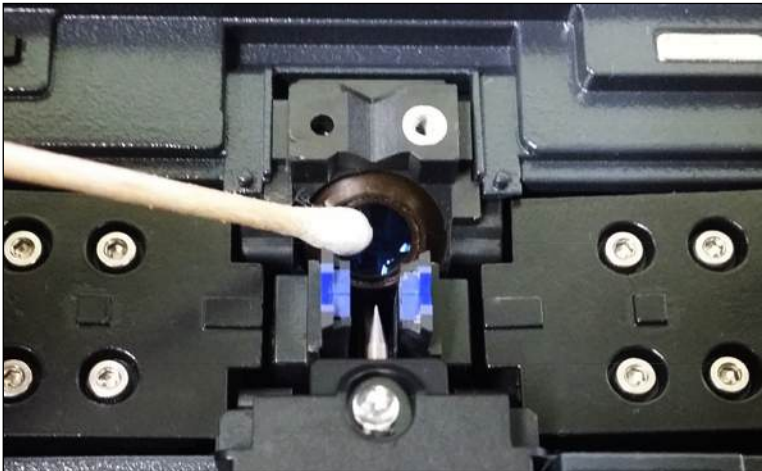

Contamination on object lens' surface disturbs distinction of optical fiber core's location and consequently incurs high splice loss. Thus, 2 object lenses should be kept clean at all times. If dust accumulates and is left for long, it may be difficult to remove. Therefore, clean the lens frequently as follows.

- 1 Turn the power off before cleaning the object lens.
- 2 Separate the electrode.
- 3 Clean it using a soft cotton swab moistened with alcohol making a circle from the center as in the figure below. Remove alcohol remaining on object lens' surface using a clean and dry cotton swab.
- 4 Surface of object lens should be clean without any line or stain.
- 5 Reassemble the electrode.
- 6 Turn the power on; check whether there is any line or stain on the monitor and; conduct Self test.

Cutter Blade Rotation

When cutter fails to cut optical fiber properly, rotate the blade as follows.

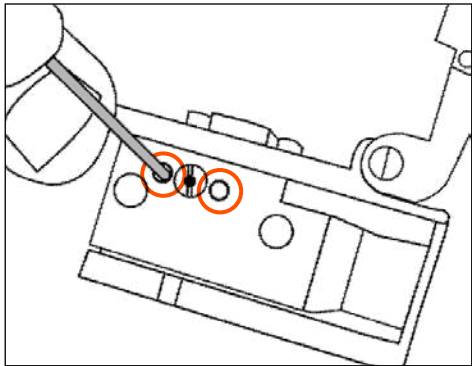

1 Unscrew the right and the left clamp screw using 1.5 hex key wrench.

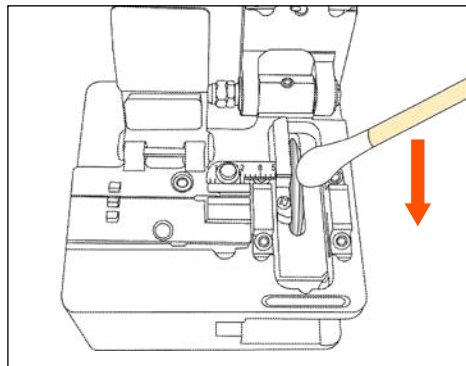

2 Rotate the blade one gauge only with a soft cotton swab. (Blade is of 16 gauges in total.)

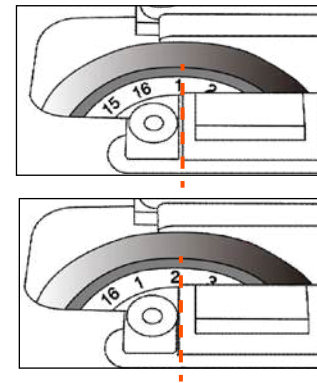

3 Tighten the right and the left clamp screw using 1.5 hex key wrench.

Electrode Replacement



- ⚠ It is recommended to replace electrode after using 3,500 times. If the actual number of arc discharge exceeds the replacing cycle, a message for electrode replacement is displayed on the screen. Without electrode replacement, splice loss increases and tensile force at splicing point weakens.

- 1 Turn the power off when replacing electrode.
- 2 Turn the power on and conduct electrode stabilizing.
- 3 Remove the electrode block and the electrode.
- 4 Clean the electrode carefully using soft cotton swab moistened with alcohol and then install it.
- 5 Turn the power on and conduct electrode stabilizing.

MENU

Ready State

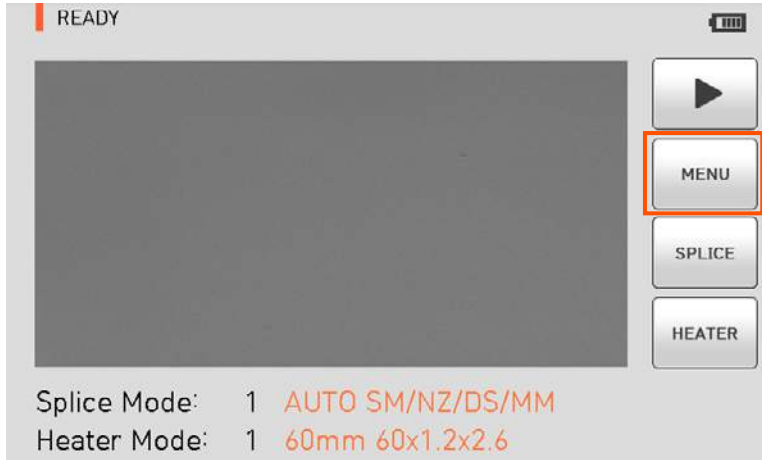

Main menu has 8 submenus. Press **MENU** or touch the **MENU** icon on the screen to load main menu. The main menu screen is as above. You can select right and left by pressing **HEAT** and **SET** buttons.



Ready State



DELETE : It deletes splice mode.
REPLACE : It selects and replaces a certain splice mode within database.
ADD : It selects and adds a certain splice mode within database.
EDIT : It edits set values of splice mode.
SELECT : It selects a splice mode to run.
CANCEL : It closes menu window.



DELETE : It deletes heater mode.
REPLACE : It selects and replaces a certain heater mode within database.
ADD : It selects and adds a certain heater mode within database.
EDIT : It edits set values of heater mode.
SELECT : It selects a heater mode to run.
CANCEL : It closes menu window.



DISPLAY HISTORY : It displays splice result and image.
CLEAR HISTORY : It deletes all data.

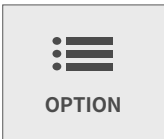

DEFAULT : Auto, Pause, Auto heater
MENU LOCK : Menu lock setting
PASSWORD : Password setting upon locking



ARC CALIBRATION : It calibrates discharge intensity.
DIAGNOSTIC TEST : It diagnoses equipment state.
MOTOR DRIVE : It operates motor manually.
MOTOR CALIBRATION : It initializes motor's speed and location.



STABILIZE : It conducts electrode stabilizing.
REPLACE : It explains how to replace electrode.
ELECTRODE CAUTION : It sets the number of uses to inform when to replace electrode.
ELECTRODE USED : It displays the electrode use count.

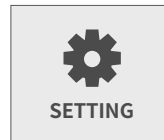

LANGUAGE : It selects a language.
DATE : It sets the present time.
POWER SAVE : It sets sleep mode.
VOLUME : It adjusts intensity of buzzer sound.
LCD BRIGHTNESS : It adjusts brightness of the screen.

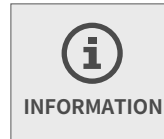

MAINTENANCE : It displays maintenance schedule.
SENSOR : It indicates temperature, pressure and humidity.
VERSION : It shows the current version of product.
HELP : It consists of the following.

- Name of each part
- Cleaning and Inspection
- Cautions
- Contact for A/S

POP-UP MENU

Popup menu of Swift K33 has been changed to a new form. Purpose of popup menu is to facilitate easy and quick access to splice mode and heater mode. User can access popup menu in various ways.

Importing Pop-up Menu

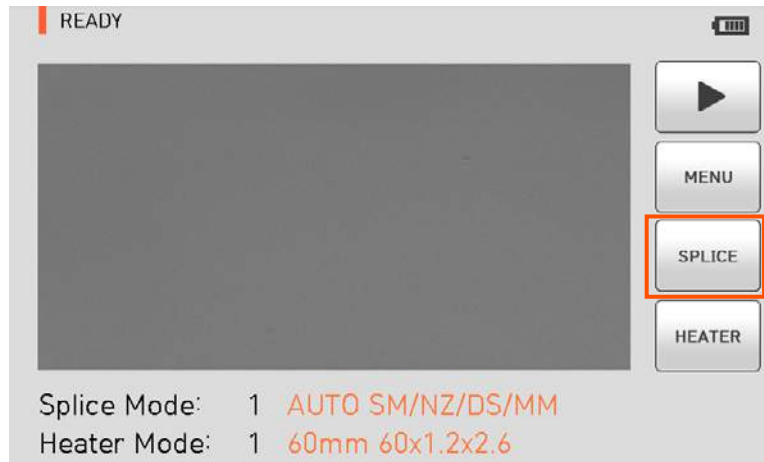

Splice Pop-Up Menu

Splice popup menu can import the current splice mode by pressing  icon on screen of Ready state.

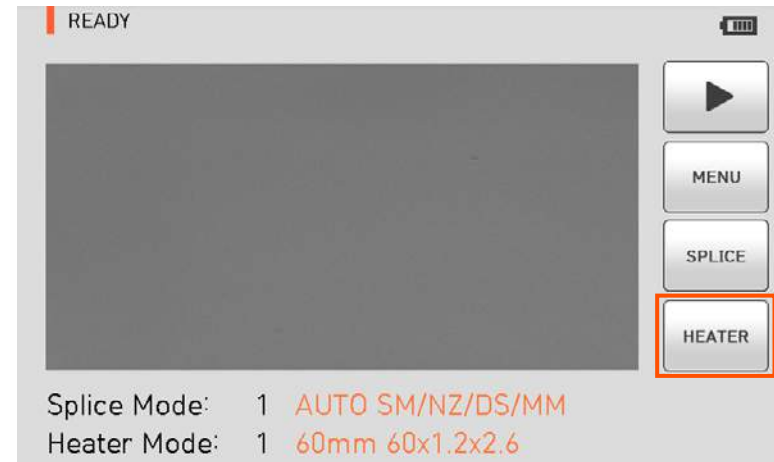

Heater Pop-Up Menu

Heater popup menu can import the current heater mode by pressing  icon on screen of Ready state.

Splice Pop-Up Menu

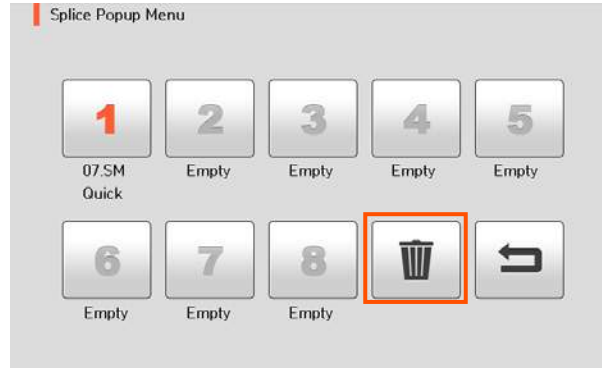
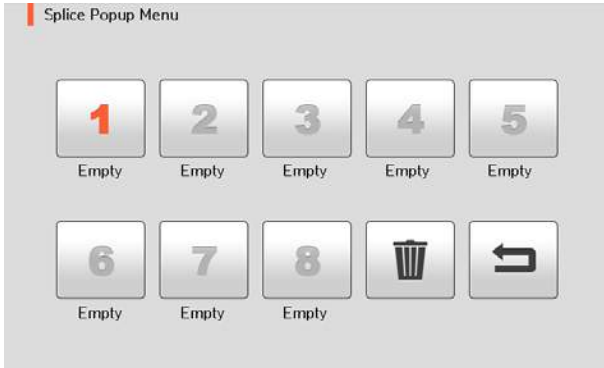

Adding Splice Menu

- 1 Import splice popup menu by pressing  icon on screen of initial state.
- 2 Select an empty slot by pressing touching the touch screen.

Deleting Splice Mode

- 1 Delete a splice mode by touching  icon.
- 2 Select a mode to be deleted.



- 3 Select a splice mode to be put in the empty slot.
- 4 Press  icon.

Heater Pop-Up Menu

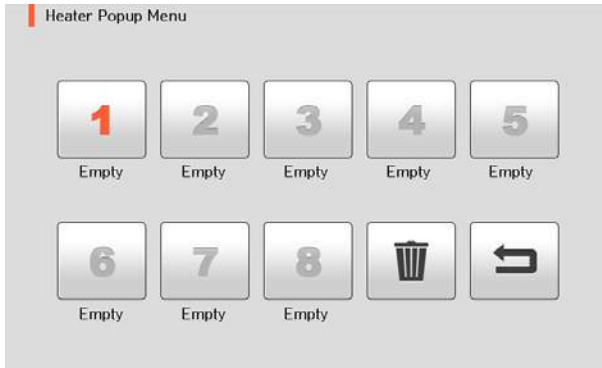



Adding Heater Menu

- 1 Import heater popup menu by pressing  icon on screen of Ready state.
- 2 Select an empty slot by pressing touching the touch screen.

Deleting Heater Mode

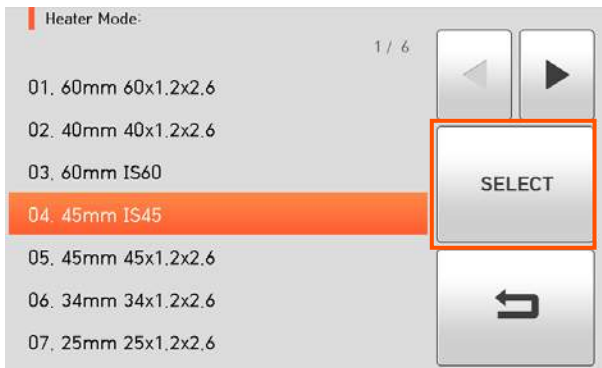
- 1 Delete a heater mode by touching  icon.
- 2 Select a mode to be deleted.



- 3 Select a heater mode to be put in the empty slot.
- 4 Press  icon.

SPLICE

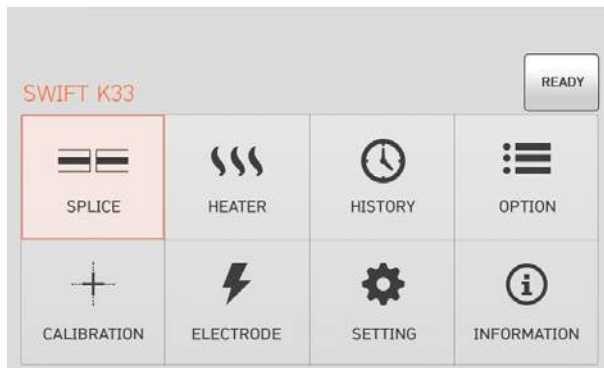

To import splice mode, press and select  icon by touch. It displays a screen to select splice mode as follows. The selecting screen is equipped with various splice modes to facilitate a user's easy selection and use of splice mode. In addition, splice mode can be expanded and saved up to 300 units. These splice modes are classified into general mode and user mode.



General splice mode : No. 1 ~ 36

User splice mode : No. 37 ~ 300

⚠ The splice mode from No.1 to No.36 can't be added, replaced or deleted.

Outline of Splice Mode

Splice Mode	Description
SM	It is a mode for basic SM optical fiber. MFD of single mode optical fiber is about 8~10um at 1310nm wavelength.
NZ	It is a mode for NZDS optical fiber. MFD of NZDS optical fiber is about 9~10um at 1550nm wavelength. WDM optical fiber can also be spliced on this mode.
DS	It is a mode for DS optical fiber. MFD of DS optical fiber is about 7~9um at 1550nm wavelength.
MM	It is a mode for MM optical fiber. Core diameter of MM optical fiber is about 50~62.5um
Other	Other splice modes are saved on database of Swift K33. New splice modes are currently being updated. Therefore, we recommend that users keep upgrading the equipment regularly by contacting UCLSWIFT.

New



1 Click **NEW**, then the splice modes stored in memory is displayed on the screen.

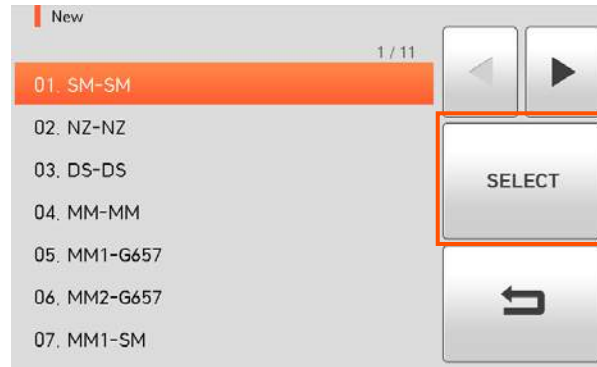

2 Select the splice mode, click **SELECT**. The selected splice mode is added the last blank mode.



3 The selected splice mode is added the last blank mode.

⚠ The splice mode from No.1 to No.36 can't be added.

Replace



1 Click **REPLACE**, then the splice modes stored in memory is displayed on the screen.

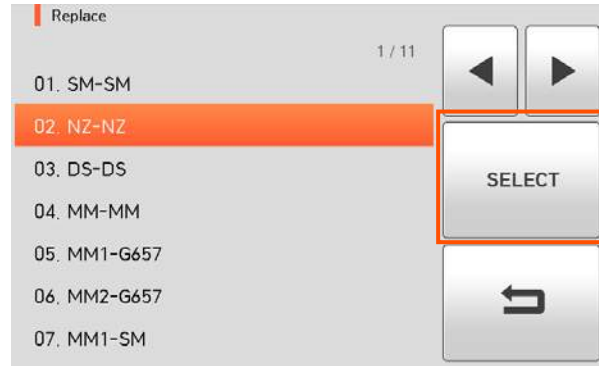

2 Select the splice mode to be replace, click **SELECT**.



3 The selected splice mode is added the last blank mode.

⚠ The splice mode from No.1 to No.36 can't be replaced.

Deleted



- 1 Firstly select the splice mode.
- 2 Click , the selected splice mode is deleted.

 The splice mode from No.1 to No.36 can't be deleted.

Edit



- 1 Click , then the splice parameters is displayed on the screen.
- 2 Select parameters, Click , adjust it for proper operation.
- 3 Click .

Editable Parameters In Mode

Set Value	Description	General Mode	User Mode
Optical Fiber Type	It displays the list of splice mode saved on sealer data to facilitate selection of a proper mode to use. Among splice modes saved on database, it copies a similar splice mode to use editing function.	Editable	Editable
Mode Title 1	Mode title 1 is to indicate splice mode within 11 letters at maximum.	Editable	Editable
Eccentricity Adjustment Function	When arraying optical fiber by using eccentricity adjustment function, it sets offset ratio of axis.	Non Editable	Editable
Automatic Power	The closer it is arrayed to the core center with fewer errors, the quicker and better the discharge is done.	Non Editable	Editable
Tensile Force Test	It conducts tensile force test after splice.	Non Editable	Editable
Cutting Angle Limit	<ul style="list-style-type: none"> It sets cutting angle's error bound. When either of cutting angles on both optical fiber is outside the bound, error message is displayed. 	Editable	Editable

Limit on Estimated Loss Value	<ul style="list-style-type: none"> · It sets estimated loss value's error bound. · When estimated loss is higher than the bound, error message is displayed. 	Editable	Editable
Limit on Optical Fiber Angle	When the bending of 2 spliced optical fibers exceeds the set bound, error message is displayed.	Non Editable	Editable
Cleaning Discharge Amount	A short cleaning discharge is conducted to remove fine dust on optical fiber's surface upon initial stage of optical fiber arrayal. It sets intensity of cleaning discharge.	Editable	Editable
Cleaning Discharge	It sets time for cleaning discharge.	Editable	Editable
Clearance Location	<ul style="list-style-type: none"> · It sets location of optical fiber spliced at the center of discharge. · When MFD of both optical fibers differs, do the sealing procedure through melting the smaller MFD optical fiber more than the bigger MFD optical fiber. To heat the smaller MFD optical fiber more, splice loss can be lowered by moving the clearance location toward the bigger MFD optical fiber at the center of discharge. 	Editable	Editable

Clearance	Upon final arrayal, it sets clearance of cross section between both optical fibers.	Non Editable	Editable
Initial Discharge Amount	It sets initial discharge amount from the beginning of discharge before optical fiber's advance. If the value of initial discharge amount is too low, the angle of optical fiber's cross section is poor and consequently, offset can be incurred on the axis and if it is too high, optical fiber can be burned too much or made round and consequently, splice loss value can be big.	Non Editable	Editable
Initial Discharge Time	It sets initial time from the beginning of discharge before optical fiber's advance. If [initial discharge time] is long, it means the same that [initial discharge amount] gets big.	Non Editable	Editable
Overlap	It sets duplication of optical fiber on optical fiber's advance amount. If [initial discharge amount] is weak or [initial discharge time] is short, set the [overlap] somewhat small and if discharge amount is strong and the time is long, set it somewhat big.	Non Editable	Editable

Discharge Amount 1	Main discharge can be adjusted in 2 levels. The first level of discharge is [discharge amount 1] and the second is [discharge amount 2]. [Discharge amount] 1 is set in this area.	Non Editable	Editable
Discharge Time 1	It sets time for [discharge amount 1]	Non Editable	Editable
Discharge Amount 2	[Discharge amount 2] is the second level of discharge. [Discharge amount 2] is set in this area.	Non Editable	Editable
Discharge Time 2	<ul style="list-style-type: none"> · It sets time for [discharge amount 2]. · It sets time for [discharge amount 2]. [Discharge time 2] is generally set as “OFF.” It can set the discharge time as a very long time period but when [discharge time 1] and [discharge time 2] exceed 30 seconds, electrode can be damaged.	Non Editable	Editable
Time Period for Discharge 2 Being On	While [discharge amount 2] is on discharge, you can set the discharge amount as ON and OFF in turn. Time period for [discharge amount 2] being On is set in this area. For re-discharge, set the discharge time as “ON” at all times.	Non Editable	Editable

Re-discharge Time	<ul style="list-style-type: none"> · It sets re-discharge time. · Within [splice mode edition], it automatically sets to discharge the re-discharge amount with the same intensity as that of [discharge amount 2]. <p>If [discharge amount 2] is set as ON/OFF, re-discharge is automatically changed.</p>	Editable	Editable
Pulling Splice	When optical fiber is made thin, splice loss is sometimes increased. This pulling function is set as “OFF.” The following 3 parameters decide the pulling shape.	Non Editable	Editable
Pulling Standby	It designates time period from the last of optical fiber advance amount to the beginning of pulling.	Non Editable	Editable
Pulling Speed	It sets optical fiber’s pulling speed.	Non Editable	Editable
Pulling Length	It sets optical fiber’s pulling time.	Non Editable	Editable

Minimum Loss	It is the sum of initially measured splice loss value and the increased loss. When splicing a special optical fiber or other optical fibers, high loss may be incurred in spite of the optimum discharge conditions. To match the estimated splice loss and the actual splice loss, the minimum value of actual splice loss should be set.	Non Editable	Editable
MFD Left	mode field diameter Left	Non Editable	Editable
MFD Right	mode field diameter Right	Non Editable	Editable

Select



Click **SELECT**, then the selected splice mode is stored in the memory for operation.

Cancel



Touch **CANCEL** icon or press **RESET** and it goes back to the previous stage

SLEEVE HEATER

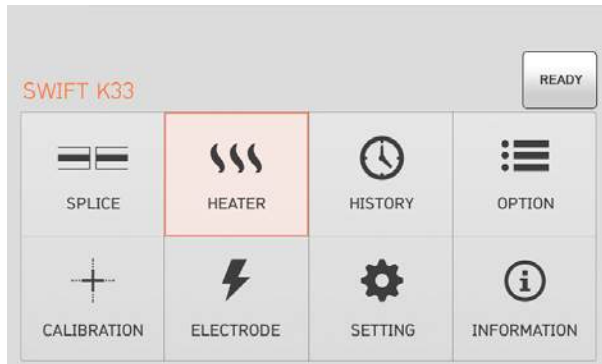

In normal operation mode, to call the heater menu, press **MENU**. Then you can see the heater menu as above.

There're already various heater mode and the user can select for proper operation. Also the heater mode will be stored up to 100.

⚠ Please note that the user can't use the Del and Replace keys and use Edit key partially from mode No 1 to No 40.



Choose the right mode for each sleeve tube type and SOC. Otherwise sleeve tubes do NOT shrink properly.

- ⚠ For the SOC, operators must use UCLSWIFT standard products. Other company's sleeve tubes may not shrink properly
- ⚠ Each heater mode heats up at different section of the heater.

Summary of Heater Mode

Set Value	Description	Others
60mm	Standard 60mm micro sleeve	
60mm IS-60	60mm micro sleeve	
45mm IS-45	45mm micro sleeve	
40mm	Standard 40mm micro sleeve	
S09	45mm sleeve	
S09-C	22mm sleeve for SOC(SC-0.9mm)	Sleeve type, mode title 1 and mode title 2 cannot be edited.
S20	45mm sleeve for 2.0mm optical cable	
S30	45mm sleeve for 3.0mm optical cable	
S30-C	32mm sleeve for SOC(SC-3.0mm)	
LC09/20-C	25mm sleeve for SOC(LC-0.9 and 2.0mm)	
ST09-C	28mm sleeve for SOC(ST-0.9mm)	
ST30-C	36mm sleeve for SOC(ST-3.0mm)	

New



1 Click **NEW**, then heater modes stored in memory is displayed on the screen.



2 Select the heater mode, click **SELECT**. The selected splice mode is added the last blank mode.



3 The selected heater mode is added the last blank mode.

⚠ The mode from No 1 to 40 can't be added.

Replace

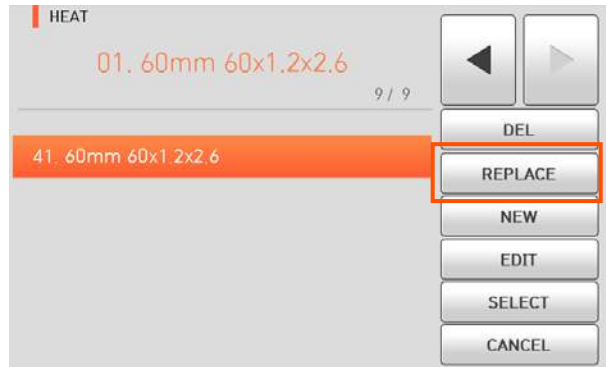

1 Click **REPLACE**, then heater modes stored in memory are displayed on the screen.



2 Select a heater mode, click **SELECT**.



3 The selected heater mode replaces the last blank mode.

⚠ The mode from No 1 to 40 can't be replaced.

Deleted

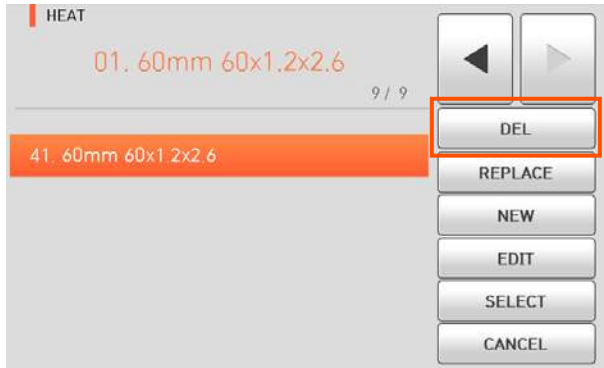

- 1 Firstly select a heater mode.
- 2 Click , the selected heater mode is deleted.

 The mode from No 1 to 40 can't deleted.

Edit



- 1 Click , then heater conditions stored in memory are displayed on the screen.
- 2 Select parameters, Click , adjust it for proper operation.
- 3 Click .

Select

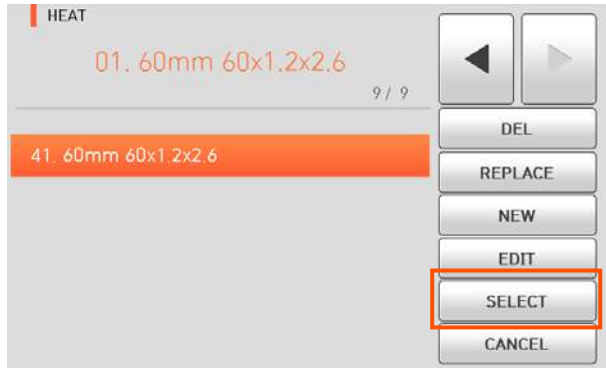

Click **SELECT** , then the selected heater mode is stored in the memory for operation.

Cancel



Touch **CANCEL** icon to go to the previous menu.

HISTORY



In normal operation mode, to call the history menu, press . Then you can see the history menu as above. There're already various functions to display data and image also copy such data to USB memory.



DISPLAY HISTORY

The 10,000 both splice loss data and image can be stored and the user can see them.

Each page has 500 loss data and splice image, click ◀ ▶ to move the page.

After choosing a data with scroll bar, click **VIEW** to see.

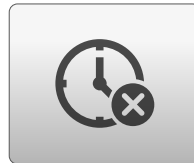

CLEAR HISTORY

Clear memory erases the whole data.

OPTION

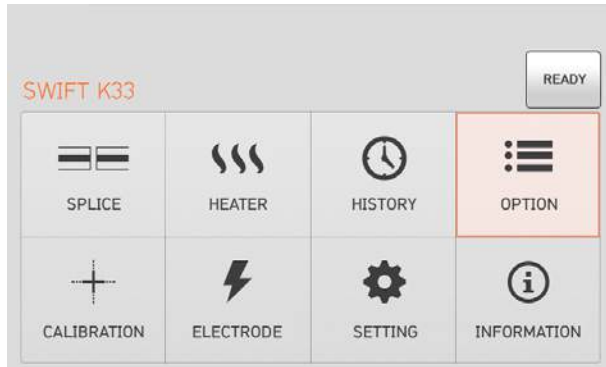

In normal operation mode, to call the option menu, press **MENU**. Then you can see the option menu as above. There're already various functions and whatever the user can select for proper operation.



DEFAULT

Default is composed of 5 sub check boxes.
To activate a Default menu, check a check box.

Parameters	Description
Auto Splice	Do splice process automatically.
Pause 1	It temporarily stops after first arrayal completes. Press SET and it goes to the next step.
Pause 2	It temporarily stops after clad arrayal completes. Press SET and it goes to the next step.
Auto Heat	Power on sleeve heater automatically after splicing process.



MENU LOCK

Default is composed of 4 sub check boxes.

To activate a Default menu, check a check box.

Also it is possible to limit the modifications with respect to the total splice mode, heat mode, and internal memory data by setting up a password.

You have to remember the password. If you forget the password, the device has to be brought to the UCLSWIFT Co., Ltd to fix it.

Parameters	Description
Splice Lock	Lock the modification of the splice mode.
Heat Lock	Lock the modification of the heat mode.
Clear Memory Lock	Lock the modification of the memory.
Password Query	To call a password window. The initial password is “1234”

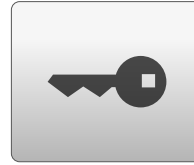

PASSWORD

Set up a new password as follow.

- 1 Enter a current password.
The initial password is “1234”
 - 2 Enter a new password. The new password can be entered within 4 - 12 digits.
 - 3 Confirm a new password.
- ⚠ If an incorrect password is entered or you press a wrong button, the screen moves to upper level.
 - ⚠ You have to remember the password. If you forget the password, the device has to be brought to UCLSWIFT Co., Ltd to fix it

CALIBRATION

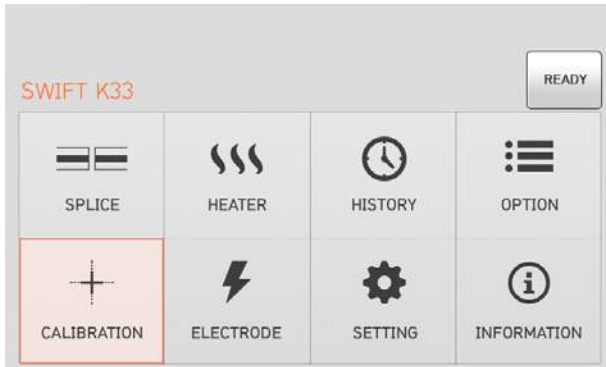

In normal operation mode, to call the calibration menu, press **MENU**. Then you can see the calibration menu as above. There're already various functions to arc test, diagnostic test and motor drive test.

⚠ Arc calibration is a function to change the value of arc discharge voltage. It is used for the computation program for splicing. In addition, the calibration value of arc discharge cannot be changed in the splice mode.

⚠ Upon discharge amount calibration, SM optical fiber should be used.



ARC CALIBRATION

Swift K33 continuously checks change in temperature and air pressure through each sensor. Based on such data, discharge amount is automatically calibrated. Change in discharge amount due to electrode abrasion or optical fiber's splice, however, is not automatically calibrated. The central axis of discharge can also be moved leftwards or rightwards with numerous discharge. In this case, discharge amount calibration is required.

- 1 Place the SM fiber to splicer.
- 2 Click .

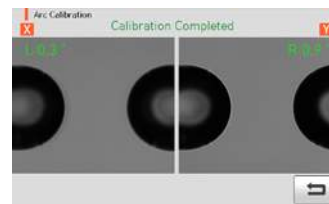

- 3 Result similar to the picture above is displayed on the screen when measuring is completed.
- 4 The calibration can be stopped by pressing **RESET** even if it has not completed.



DIAGNOSTIC TEST

Self test is a function to facilitate dust test, LED test and motor test and calibration at a time.

Test Item	Description
Dual Test	Refer on Dust Test, without fiber.
LED Test	Refer on LED Check, without fiber.
Motor Test	Refer on Motor Test, without fiber.
Heater Test	Refer on Heater Test, without fiber.



MOTOR DRIVE

It checks the operating status of the motor manually.

- 1 Place the fiber in the splice.
- 2 Click “Motor Drive”.

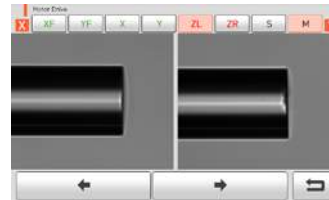

- 3 Touch screen to change motor selection. The name of the selected motor is displayed at the top left on the screen.
- 4 Operate the motor in a direction wanted by touching arrow icons at the bottom.

Motor		
ZL/ZR	ZL/ZR Move forward	ZL/ZR Move backward
S	Move step by step press a button.	
M	Move while pressing a button.	



MOTOR CALIBRATION

Motor setting is set on sealer as default but depending on motor setting location, splice speed may slow down. If speed slow down during the splice operation or any abnormality is incurred on entering position, motor setting can be automatically calibrated through this function.

- 1 Put optical fiber on sealer.
- 2 Select “Motor calibration” by touching it.
- 3 Click  .
- 4 If an error message is displayed after testing, contact to UCLSWIFT immediately.
- 5 End the calibration by pressing **RESET** .

ELECTRODE



In normal operation mode, to call the Electrode menu, press **MENU**. Then you can see the Electrode menu as above. It is necessary to regularly check and clean the electrodes because they are worn out. The silica oxidized substances is deposited as the electrodes go through numerous times of splices. There're already various functions to arc count, replace time and other.



STABILIZE

Sometimes, surrounding environment may cause the occurrence of irregular arc discharge or splice loss increase. In particular, since it takes a while until discharge is stabilized when the splicer is in lower or higher location, you have to keep adjusting the discharge until the electrodes are stabilized. Especially after installing new set of electrodes, he user must do Electrode Stabilize as follows.

- 1 Place the fiber in the arc fusion splicer.
- 2 Click "Stabilize"
- 3 Click .
- 4 Perform 30 cycle continuous arc discharge to stabilize the electrodes.

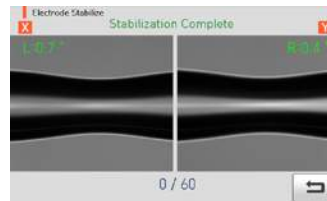

- 5 Result similar to the picture above is displayed on the screen when measuring is completed.
- 6 After completing the Electrode Stabilize, ARC Calibration should be performed separately.

**REPLACE**

The recommended replacement cycle of an electrode is 18,000 times use.
When the set cycle completes, a message to replace the electrode appears.

**ELECTRODE USED**

It displays the used arc count.

**ELECTRODE CAUTION**

It determines the arc count for alert message.
The recommended replacement cycle of an electrode is 18,000 times use.

SETTING

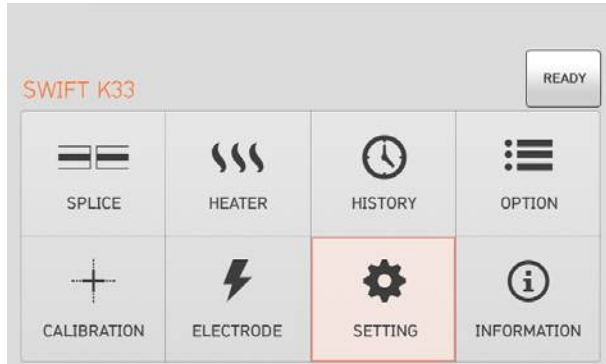

In normal operation mode, to call the setting menu, press **MENU**. Then you can see the Setting menu as above.



LANGUAGE

It sets a language to be displayed on the screen.

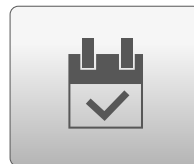

DATE

It sets the date and time in the calendar.

**POWER SAVE**

It is an important function in terms of energy efficiency. When the Swift K33 operates with a battery, we recommend activate this function to increase your working time.

**• MONITOR**

The LCD will be automatically turned off, if you don't operate the Swift K33 for a setting time. The monitor is turned on again when you press any button.

**• SPLICER**

The Swift K33 will be automatically turned off, if you don't operate it for a time set. The Swift K33 is turned on again only when you press .

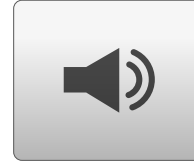
**VOLUME**

To adjust the buzzer volume.

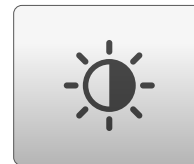
**LCD BRIGHTNESS**

To adjust a monitor brightness.

INFORMATION



In normal operation mode, to call the Electrode menu, press **MENU**. Then you can see the Electrode menu as above. It is necessary to regularly check and clean the electrodes because they are worn out. The silica oxidized substances is deposited as the electrodes go through numerous times of splices. There're already various functions to arc count, replace time and other.



MAINTENANCE

Click “Maintenance”, following information is displayed.

Item	Description
Produce Date	The date when equipment was manufactured. (year, month and date).
Electric Number	Arc discharge count since the replacement of the electrode.
Total Electric Number	Total arc discharge count since its first operation.
Last Maintenance	The date when the device was maintained most recently.
Next Maintenance	The date when the device will be maintained next time.
Serial Number	The unique serial number given to the device.

MENU



SENSOR

The splicer consists of various sensors including temperature, pressure and humidity.

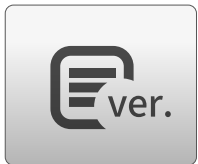

VERSION

The version can be easily upgraded by connecting to PC and using Data Syn program (PC Program).



HELP

Click “HELP”, following help is displayed.



- **THE NAMES OF PARTS**

The main part of the Swift K33.



- **CLEAN AND INSPECT**

How to clean and inspect.



- **WARNINGS**

Warnings.



- **A/S CONTACT LIST**

Service contact point.

ERROR MESSAGE

Too Dirty Fiber



It is displayed when the fiber prepared for splice is contaminated more than normal status.

HOW TO

- Reset the fiber after cleaning.

Replace the Optical Fiber



It is displayed when the fiber is not placed in the middle of the electrodes and V-groove or the objective lenses or reflection mirror is contaminated.

HOW TO

- Press **RESET** and place the fiber in the middle of the electrodes and V-groove.
- Check the condition of the lenses and reflection mirror and remove any dirt.

Too Long Fiber

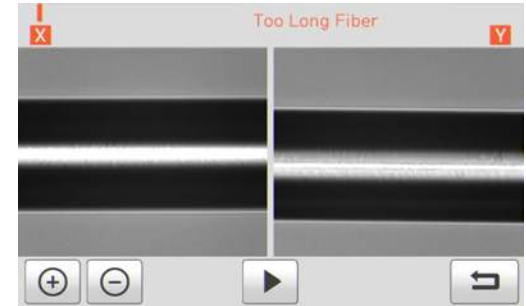

It is displayed when the fiber is placed too close to the electrode, the lenses or reflection mirror is dirty or LED light is not bright enough.

HOW TO

- Press **RESET** and place the fiber again.
- Remove dust and dirt from the lenses and reflection mirror.
- Conduct an LED test. If an error occurs, contact UCLSWIFT Co., Ltd.

Fiber Over Angle

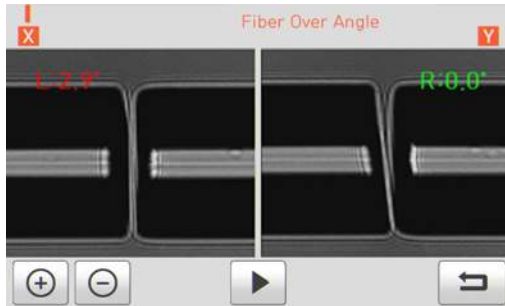

It is displayed when the measured cleaving angle of the fiber is greater than the limit.

HOW TO

- Reset the fiber after checking the condition of the cleaver.
- Check the value of the cleaving angle.

Loss Is Higher



It is an error message generated when estimated loss value is higher than the preset loss factor limit.

HOW TO

- Check the loss factor limit.

Core Bubble Error

It is displayed when bubbles or dots exist in the spliced part after completing the splice.

HOW TO

- Check the condition of the cleaver.
- Clean the V-groove.
- Check the condition of the electrode.

Optical Fiber Is Thick

It is an error message generated when optical fiber sealing part becomes thicker than the standard after sealing.

HOW TO

- Reduce the overlap set value.
- Check whether discharge amount or discharge time is set as too small or too short respectively.

Optical Fiber Is Thin

It is an error message generated when optical fiber sealing part becomes thinner than the standard after sealing.

HOW TO

- Make adjustment to shorten the pulling length of pulling splice.
- Check whether discharge amount or discharge time is set as too big or too long respectively.

Error on Cut Surface on Left, Right or Both

It is an error message generated when the cut surface of optical fiber is poor quality.

HOW TO

- Check the state of optical fiber cutter.
- Cut the optical fiber yet again.

WHEN THE SPLICE LOSS IS TOO HIGH

It may have been caused by dirt or dust on the surface of fibers.

HOW TO

- Carefully clean the surface of the fibers.
 - DO NOT clean the optical fiber after cutting to prevent dust from being gathered on optical fiber's cross section.
 - DO NOT push in the optical fiber when putting it on V-Groove. Optical fiber should be placed from top to bottom V-Groove.
-

The arrangement of the fibers can be interrupted by the dirt in the V-groove.

HOW TO

- Keep the V-groove clean at all times.
-

Bad electrodes

HOW TO

- Replace the electrodes.
The tips are bent or contaminated if they are worn out.

Improper arc discharge or arc discharge time.

HOW TO

- Check the set values of arc discharge amount and arc discharge time and reset them, if necessary.
 - The machine is delivered after being set to the most optimized values from the factory.
-

Inappropriate splice mode

HOW TO

- Check if the proper splice mode for the fiber has been selected.

ABNORMAL OPERATION OF ARC FUSION SPLICER

The alignment motion is repeated.

HOW TO

- Open and close the windshield cover again
- Rest the system by pressing **RESET** when an error occurs by opening the windshield cover. Turn off the power and contact UCLSWIFT Co., Ltd.

The error message of “Too Long Fiber” appears repeatedly.

HOW TO

- Reset and turn off the power. Contact UCLSWIFT Co., Ltd.

POWER

Unable to turn off the power by pressing .

HOW TO

- Press the switch and hold it for about 1 second and release the button when the monitor is turned off.
-

Unable to splice as number of times as the splicer normally does with the battery that has been fully charged.

HOW TO

- If the power saving mode is not activated, the battery runs out quickly. Please refer to [Setting Menu] for more information. If the battery has not been used for a while, charge it again until it is charged fully.
- Use a new battery if the current battery was used for a long period of times and its suggested lifetime is passed. Since the battery works based on chemical reactions, power generated decreases at a low temperature and, in particular, it runs out very quickly when the temperature is below zero. Also, the battery runs out fast when it is used at a high temperature because the power consumption increases. If you cannot charge the battery fully, do as instructed below.

LED is not turned on while charging the battery.

HOW TO

- Disconnect the AC power cord from the charger and connect the DC cord to the charging jack. Connect the AC power cord in 10 to 15 seconds. The LED of the battery is turned on red and charging begins
-

Remaining battery is not indicated.

HOW TO

- Charge the battery.
-

Remaining battery is not well displayed.

HOW TO

- Remaining battery display is for reference.

SPLICE

When an error message appears on the screen.

HOW TO

- Refer to the [Error message list] for detailed information.
-

Irregular or higher splice loss.

HOW TO

- Clean V-Groove, V-Block, reflector and object lens by referring to [Maintenance of splice quality]. Replace electrode by referring to [Electrode replacement]. Refer to the “High estimated loss” from [Error message list].
 - If optical fiber warps or is bent, place the optical fiber’s bent direction to face the bottom. Splice loss varies depending on cutting angle, discharge condition and cleanliness level of optical fiber. Splice loss is still high or irregular even after implementin the above recovery measures, contact to UCLSWIFT. Annual maintenance is required to keep splice quality.
-

Monitor is turned off suddenly.

HOW TO

- Press any key and check [Monitor Power Save].

The power of the splicer is turned off suddenly.

HOW TO

- Turn on the splicer again and check [Splicer Power Save].
-

Unable to change arc discharge amount and time.

HOW TO

- On SM, NZ, MM or AUTO mode, either discharge amount or discharge time cannot be changed. Implement [discharge amount calibration], and the discharge amount on these modes is properly maintained. When used on another mode, discharge amount and discharge time are automatically set to prevent their alteration.
-

How to set pause.

HOW TO

- Refer to [Option Menu].

How to indicate cutting angle, optical fiber's angle and core/clad deviation.

HOW TO

- Refer to [Option menu].
-

Difference between estimated splice loss and measured splice loss.

HOW TO

- The estimated splice loss is just a result from computation so it has to be used for reference only.
-

SLEEVE HEATER

The sleeve heater does not give sufficient shrinkage.

HOW TO

- Increase the duration of heating time.
Refer to [Heat Menu] for more information.

The sleeve heater is overheated.

HOW TO

- Stop the operation of the heater by pressing **HEAT**.
Turn off the power and contact UCLSWIFT Co., Ltd.
 - When the sleeve is not separated from the heating plate, use a cotton swab or a similar object to this to push or remove the sleeve.
-

How to initialize the heating condition in the heat mode.

HOW TO

- Refer to [Heat Menu] for more information.
-

How to cancel the heating process.

HOW TO

- You cannot cancel the heating process by pressing **RESET**.
Press **HEAT** one more time to cancel it

THE OTHERS

How to lock “Splice”, “Edit” or heat mode.

HOW TO

- Refer to [Lock Menu] for more.
-

Arc amount is not changed after performing [Arc Calibration].

HOW TO

- The internal standard discharge amount is calibrated.
Therefore discharge amount of each splice mod
does not change.
-

If you forget the password.

HOW TO

- Contact UCLSWIFT Co., Ltd.



WARRANTY

Limited Liability

UCLSWIFT warrants its products against defects in material and workmanship. Under normal use and service, every hardware portion of the products will be free from physical defects in material and workmanship during the warranty period, or the product will be repaired or replaced as determined solely by UCLSWIFT.

Customers will be charged for the repair of the machine even if in-warranty period, if such defect or damage occurred as a result of.

- 1 Natural disaster(s)
- 2 Applying over-voltage
- 3 Customer's mishandling
- 4 Customer's misuse without following instructions or operation procedures provided by this user manual
- 5 Expendables (including electrode)



Information Required For Repair

Before sending the splicer to us, it is necessary to contact UCLSWIFT Co., Ltd first.

- 1 Give us following information by attaching paper on the product. (Name, Department, Company, Address, Contact information, FAX, E-MAIL)
- 2 Product's serial number
- 3 Product's state and problem incurred, information on error message
- 4 Product handling with disregard on working procedure or directions written on instructions for use

Transport

The Swift K33 is high precision equipment, so it is required to transport after keeping it in a safe case to protect it from humidity, vibration and physical shock. In case of request for repair, it must be in the case along with its parts before its transport.

Repair

Any data saved in the memory including splice results and splice modes may be deleted as a result of repair.



PRODUCT WARRANTY

NAME OF PRODUCT SWIFT K33

PRODUCTION NUMBER

DATE OF PURCHASE

CUSTOMER NAME **TEL.**

ADDRESS

Limited Warranty

1. This product is manufactured under strict quality management and inspection processes
2. UCLSWIFT Co., Ltd. warrants this product against defective materials and workmanship for a period of one year from the date of purchase. However, this warranty does not cover a damage or failure caused by or attributable to a reason for Exclusion and Limitations even if the equipment is still under warranty
3. This warranty card has to be presented when the product is repaired
4. The arc fusion splicer is high precision equipment, so it is required to transport after keeping it in an exclusive carrier case to protect it from humidity, vibration and physical shock

Exclusion and Limitations

- This warranty will not cover a damage or failure and charges (repairing charge + part + travel expenses) will apply even if the equipment is still under warranty, if such damage or failure has occurred due to or when
1. Natural disaster
 2. Applying over-voltage
 3. Customer's mishandling
 4. Customer's misuse without following instructions or operation procedures provided by this user manual
 5. The stamped seal is broken or damaged

When you require maintenance or repair service, please contact the service center or the dealer you purchased the machine.